

DATA SHEET

BF851A; BF851B; BF851C N-channel junction FETs

Product specification
File under Discrete Semiconductors, SC07

1995 Apr 14

Philips Semiconductors



PHILIPS

N-channel junction FETs

BF851A; BF851B; BF851C

FEATURES

- High transfer admittance
- Low input capacitance
- Low feedback capacitance
- Low noise.

APPLICATIONS

- Preamplifiers for AM tuners in car radios.

DESCRIPTION

N-channel symmetrical junction field effect transistors in a SOT54 (TO-92) package.

PINNING - SOT54 (TO-92)

PIN	SYMBOL	DESCRIPTION
1	g	gate
2	s	source
3	d	drain

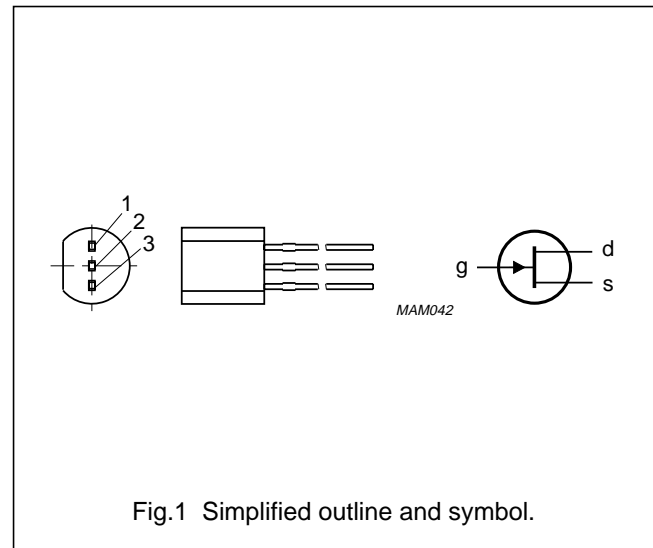

Fig.1 Simplified outline and symbol.

CAUTION

The device is supplied in an antistatic package. The gate-source input must be protected against static discharge during transport or handling.

QUICK REFERENCE DATA

SYMBOL	PARAMETER	CONDITIONS	MIN.	MAX.	UNIT
V_{DS}	drain-source voltage (DC)		–	25	V
I_{DSS}	drain current BF851A BF851B BF851C	$V_{GS} = 0; V_{DS} = 8\text{ V}$	2 6 12	6.5 15 25	mA mA mA
P_{tot}	total power dissipation	up to $T_{amb} = 40\text{ °C}$	–	400	mW
$ y_{fs} $	forward transfer admittance BF851A BF851B BF851C	$V_{GS} = 0; V_{DS} = 8\text{ V}$	12 16 20	20 25 30	mS mS mS
C_{iss}	input capacitance	$f = 1\text{ MHz}$	–	10	pF
C_{rss}	reverse transfer capacitance	$f = 1\text{ MHz}$	–	3	pF

N-channel junction FETs

BF851A; BF851B; BF851C

LIMITING VALUES

In accordance with the Absolute Maximum Rating System (IEC 134).

SYMBOL	PARAMETER	CONDITIONS	MIN.	MAX.	UNIT
V_{DS}	drain-source voltage (DC)		–	25	V
V_{GSO}	gate-source voltage	open drain	–	25	V
V_{DGO}	drain-gate voltage (DC)	open source	–	25	V
I_G	forward gate current (DC)		–	10	mA
P_{tot}	total power dissipation	up to $T_{amb} = 40\text{ °C}$; note 1	–	400	mW
T_{stg}	storage temperature		–65	+150	°C
T_j	operating junction temperature		–	150	°C

Note

1. Device mounted on an epoxy printed-circuit board; maximum lead length 4 mm; mounting pad for the drain lead minimum 10 mm².

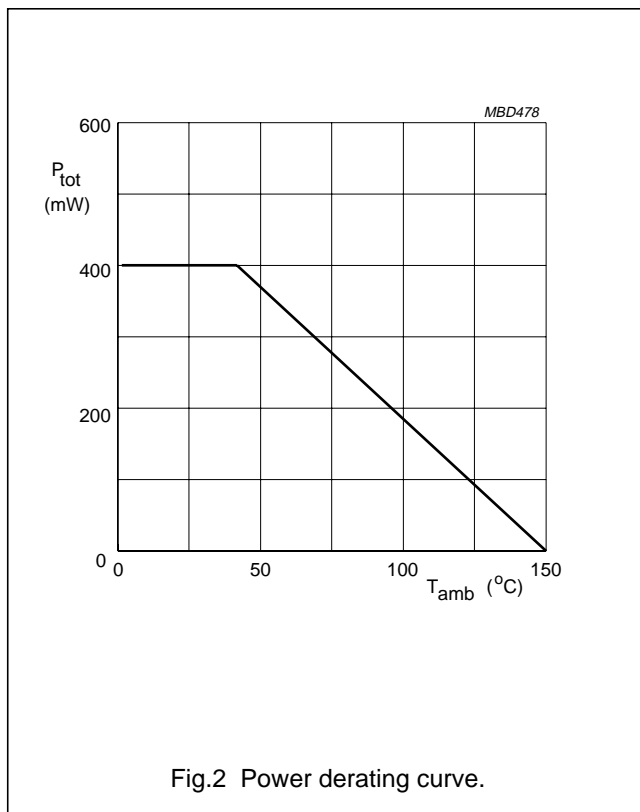

N-channel junction FETs

BF851A; BF851B; BF851C

THERMAL CHARACTERISTICS

SYMBOL	PARAMETER	VALUE	UNIT
$R_{th\ j-a}$	thermal resistance from junction to ambient; note 1	250	K/W

Note

1. Device mounted on an epoxy printed-circuit board; maximum lead length 4 mm; mounting pad for the drain lead minimum 10 mm².

CHARACTERISTICS

$T_j = 25\text{ °C}$; $V_{DS} = 8\text{ V}$; $V_{GS} = 0$; unless otherwise specified.

SYMBOL	PARAMETER	CONDITIONS	MIN.	TYP.	MAX.	UNIT
$V_{(BR)GSS}$	gate-source breakdown voltage	$I_G = -1\ \mu\text{A}$	-25	-	-	V
V_{GSoff}	gate-source cut-off voltage	$I_D = 1\ \mu\text{A}$				
	BF851A		-0.2	-	-1	V
	BF851B		-0.5	-	-1.5	V
	BF851C		-0.8	-	-2	V
V_{GSS}	gate-source forward voltage	$V_{DS} = 0$; $I_G = 1\ \text{mA}$	-	-	1	V
I_{DSS}	drain current					
	BF851A		2	-	6.5	mA
	BF851B		6	-	15	mA
	BF851C		12	-	25	mA
I_{GSS}	gate cut-off current	$V_{GS} = -20\ \text{V}$; $V_{DS} = 0$	-	-	-1	nA
$ y_{fs} $	forward transfer admittance					
	BF851A		12	-	20	mS
	BF851B		16	-	25	mS
	BF851C		20	-	30	mS
g_{os}	common source output conductance					
	BF851A		-	-	200	μS
	BF851B		-	-	250	μS
	BF851C		-	-	300	μS
C_{iss}	input capacitance	$f = 1\ \text{MHz}$	-	-	10	pF
C_{rss}	reverse transfer capacitance	$f = 1\ \text{MHz}$	-	2.4	3	pF
V_n/\sqrt{B}	equivalent input noise voltage	$V_{GS} = 0$; $f = 1\ \text{MHz}$	-	1.5	-	$\text{nV}/\sqrt{\text{Hz}}$

N-channel junction FETs

BF851A; BF851B; BF851C

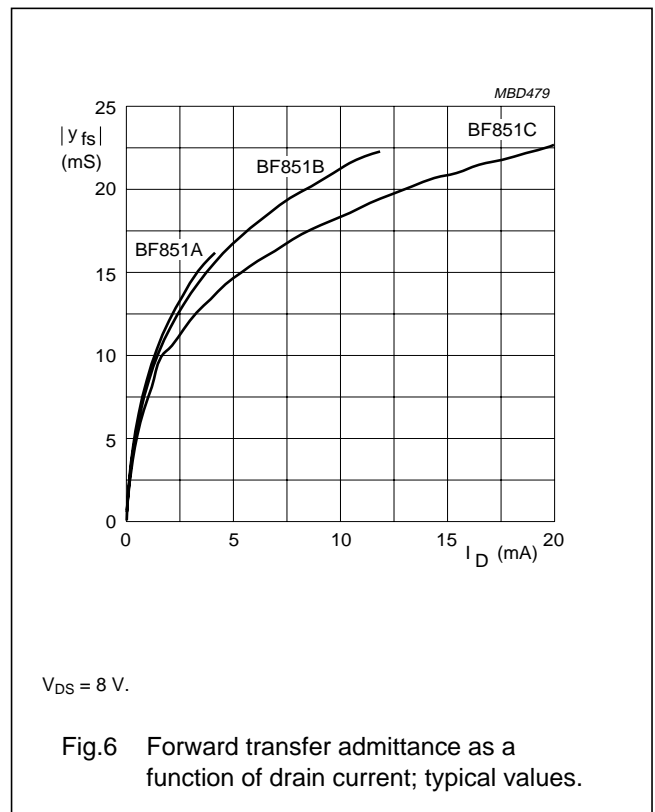
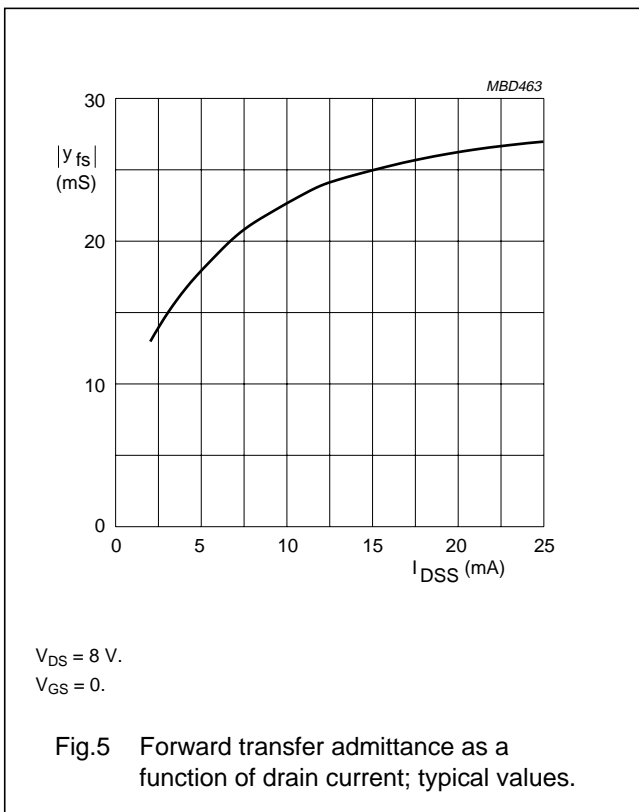
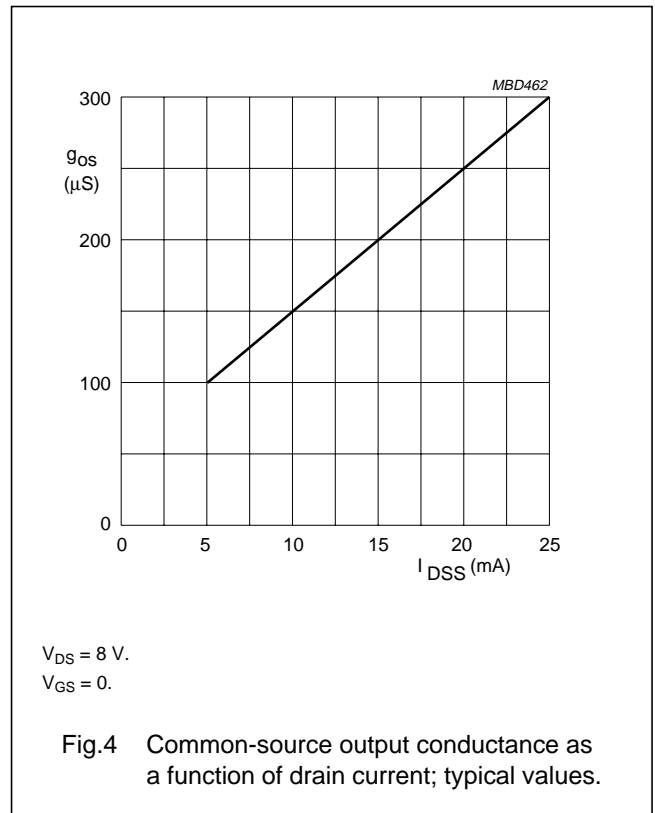
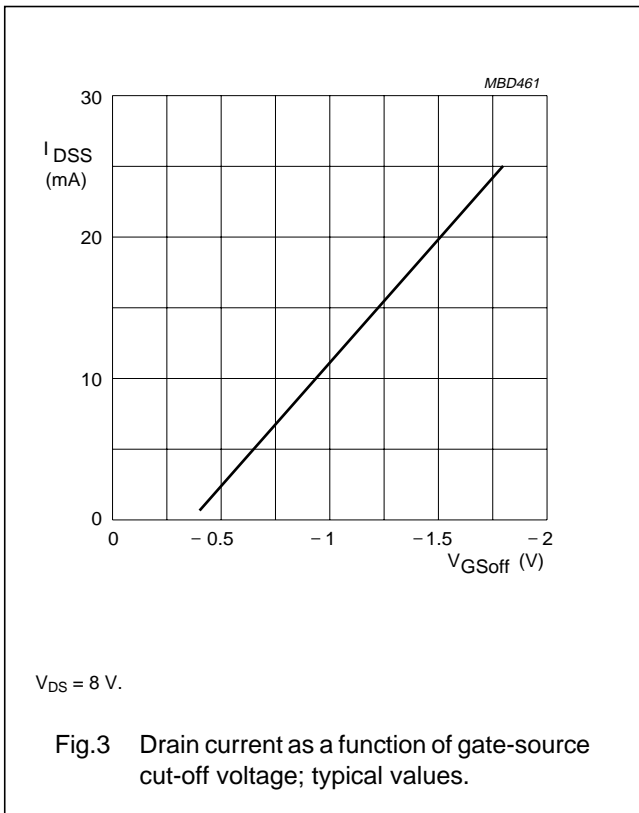

N-channel junction FETs

BF851A; BF851B; BF851C

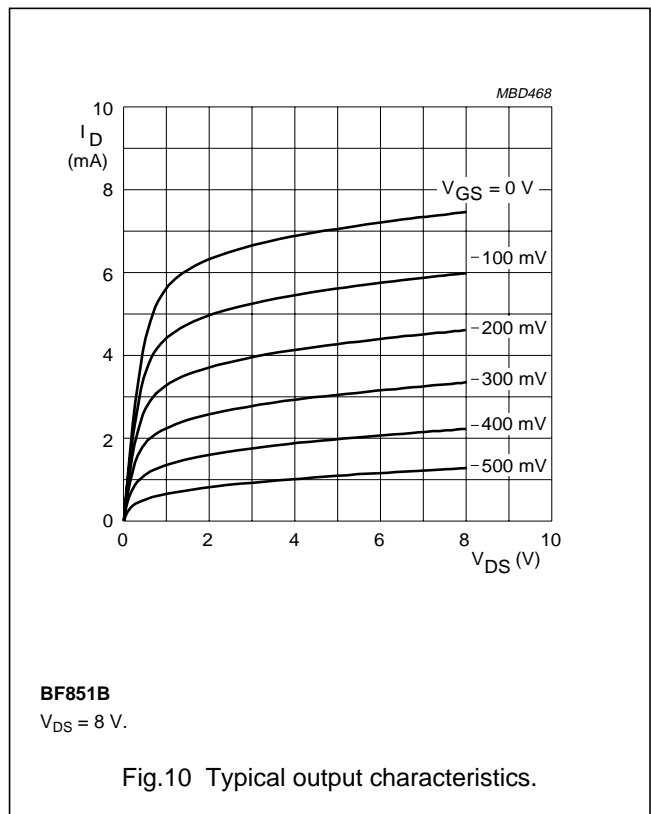
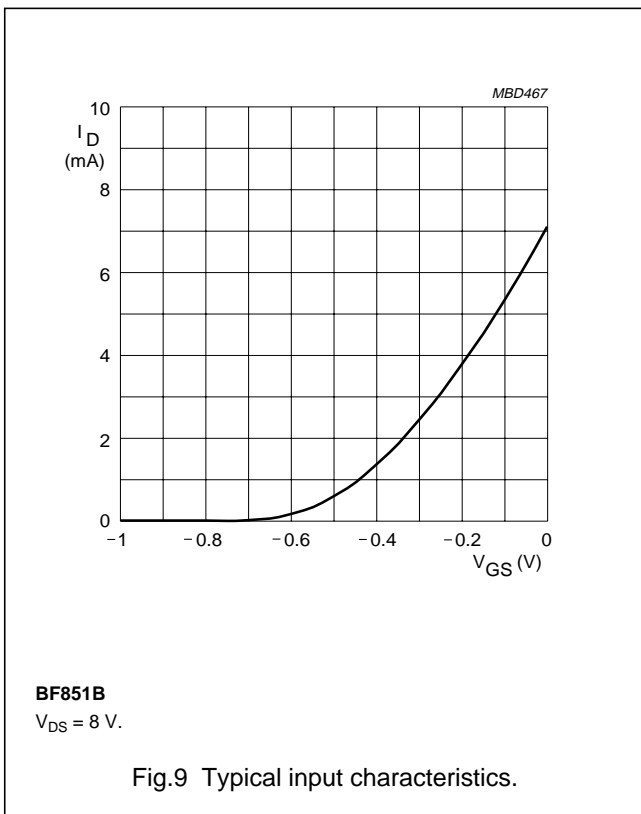
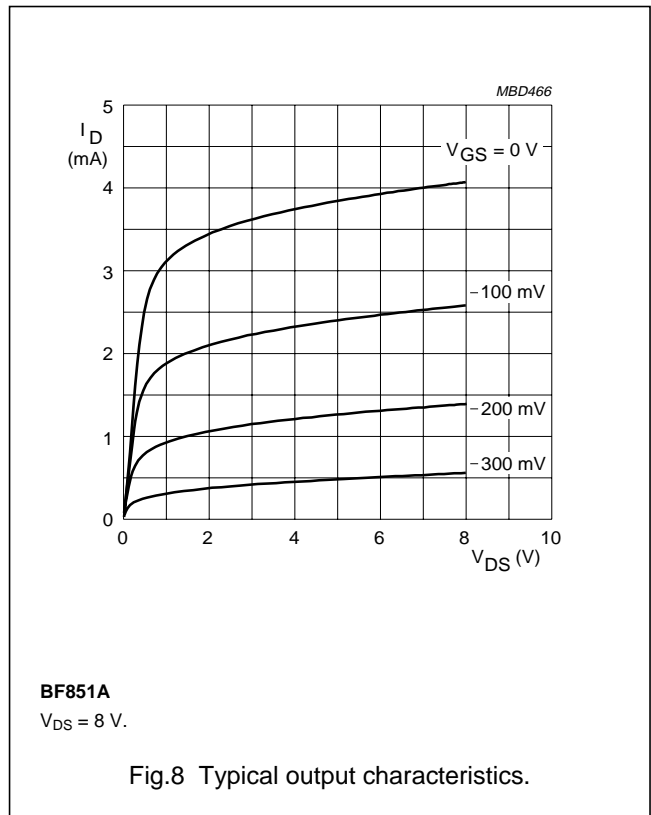
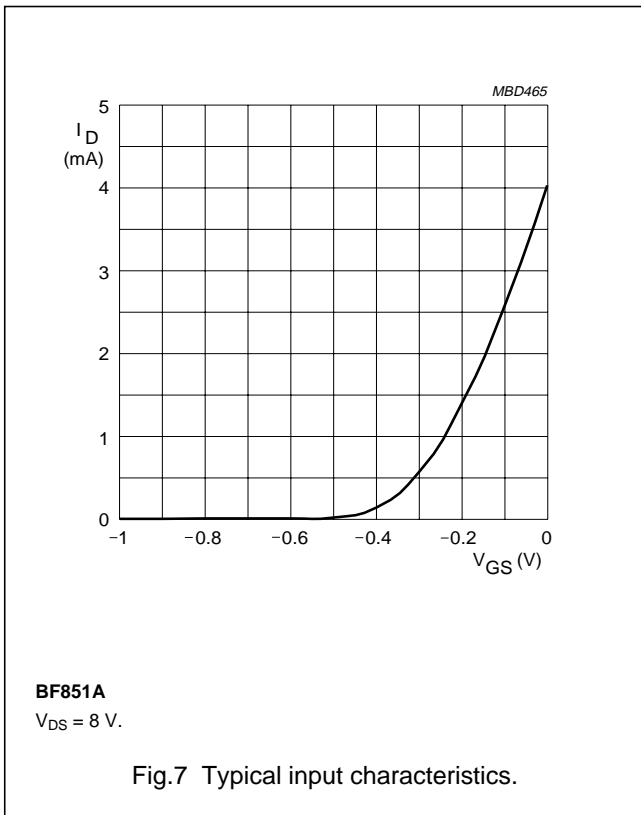

N-channel junction FETs

BF851A; BF851B; BF851C

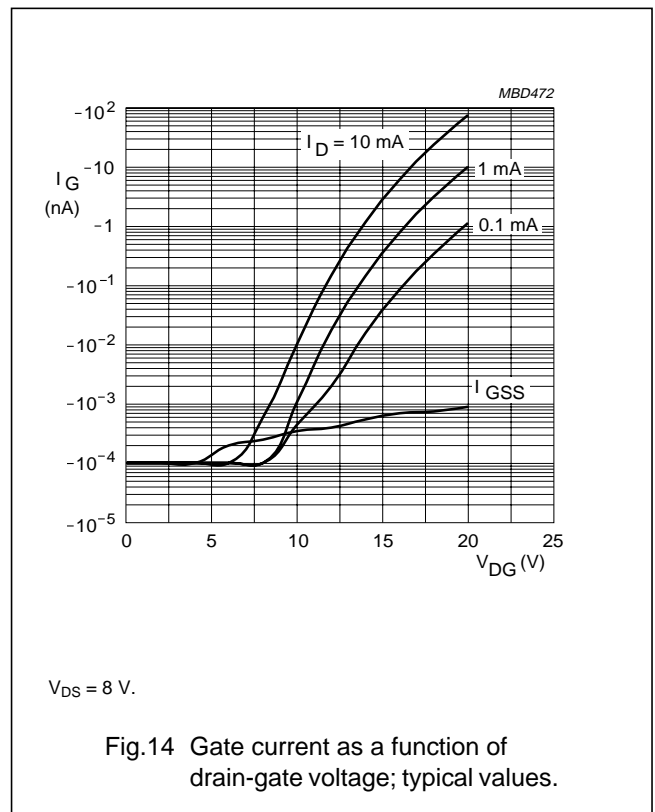
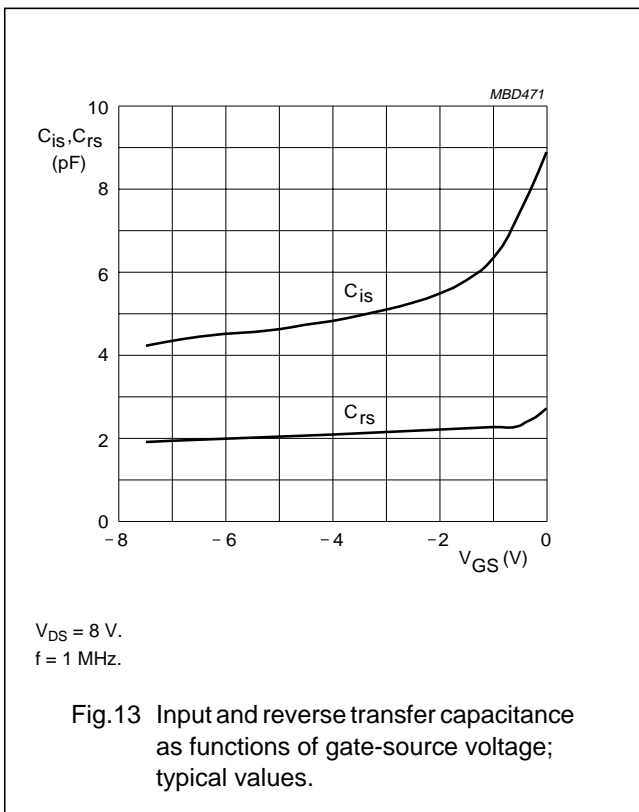
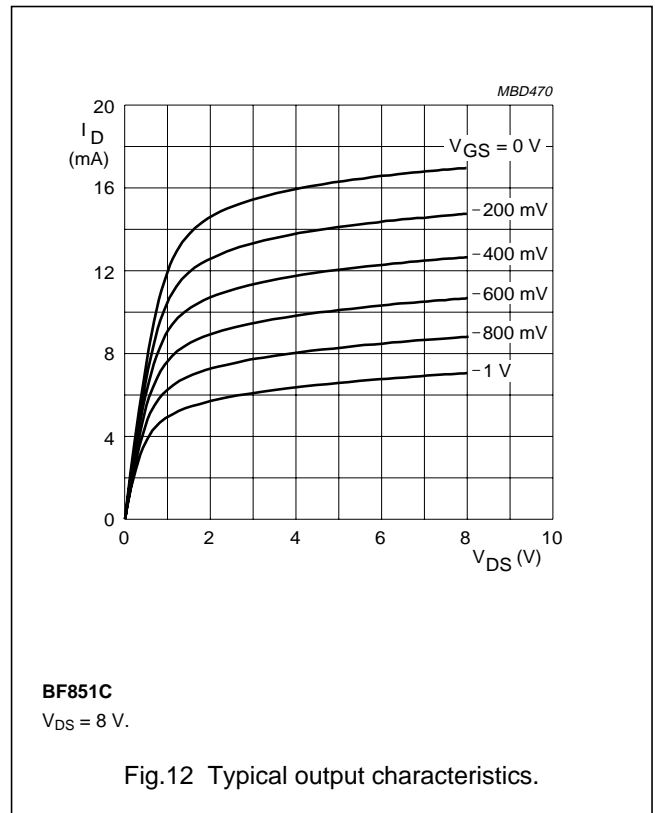
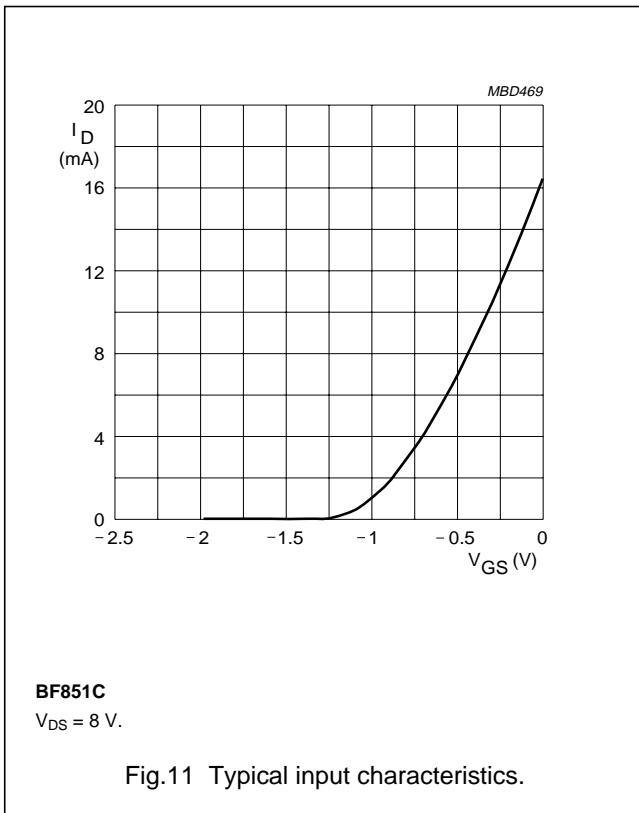

N-channel junction FETs

BF851A; BF851B; BF851C

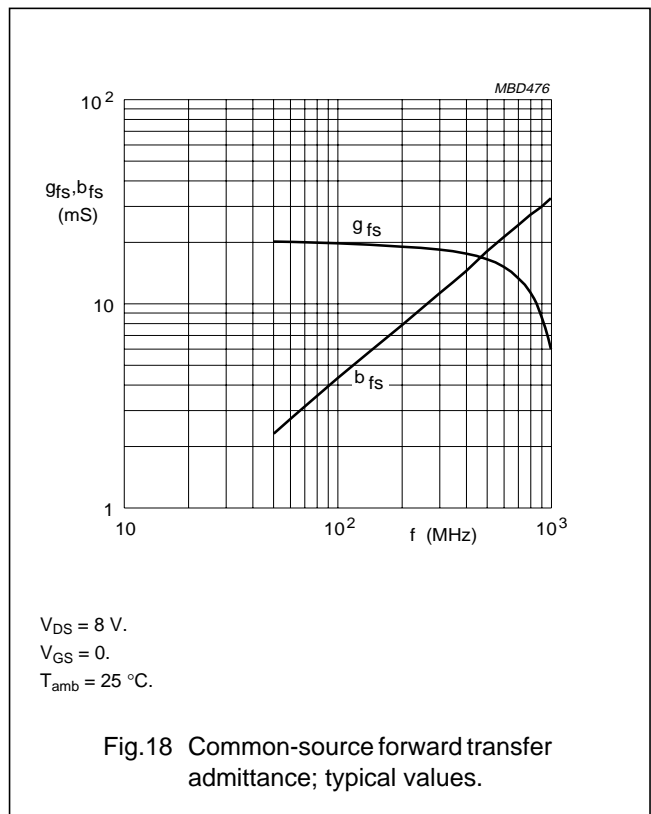
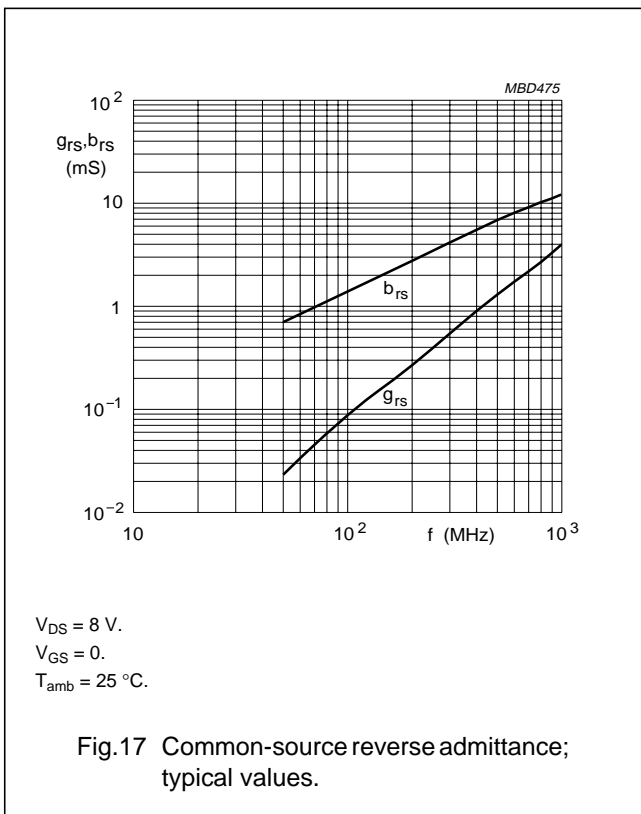
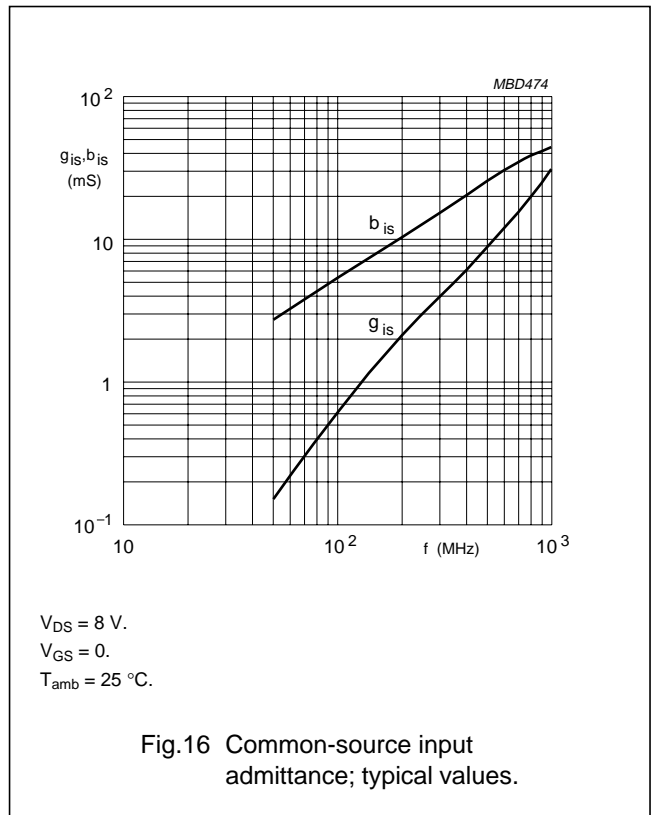
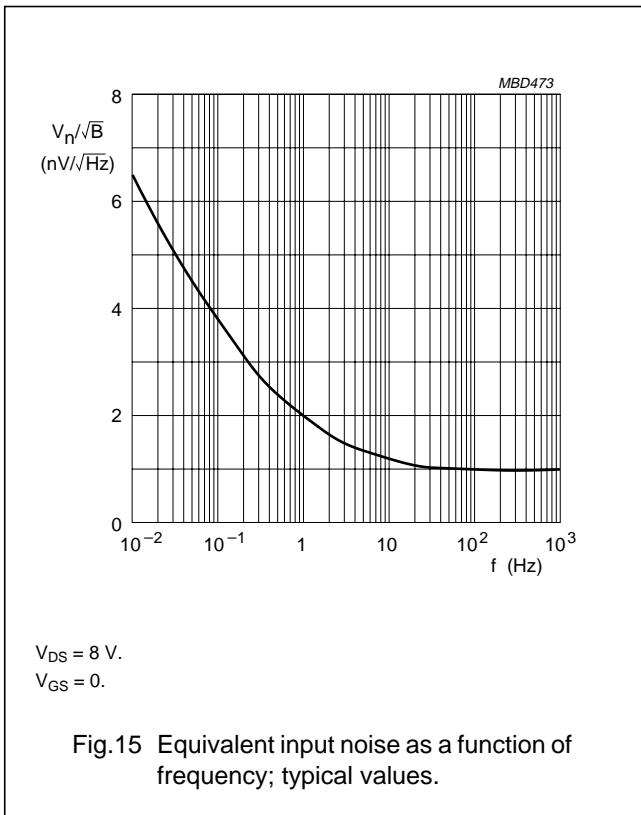

N-channel junction FETs

BF851A; BF851B; BF851C

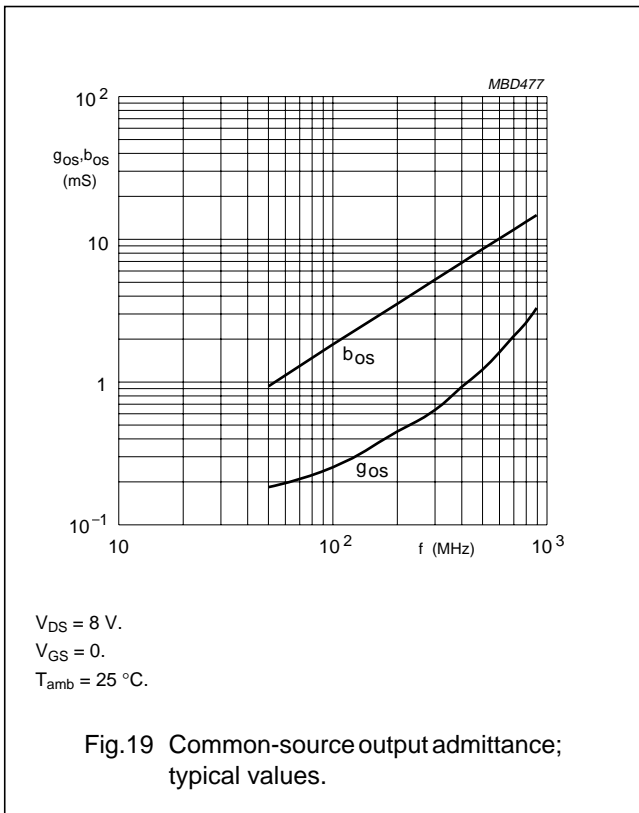

N-channel junction FETs

BF851A; BF851B; BF851C

PACKAGE OUTLINE

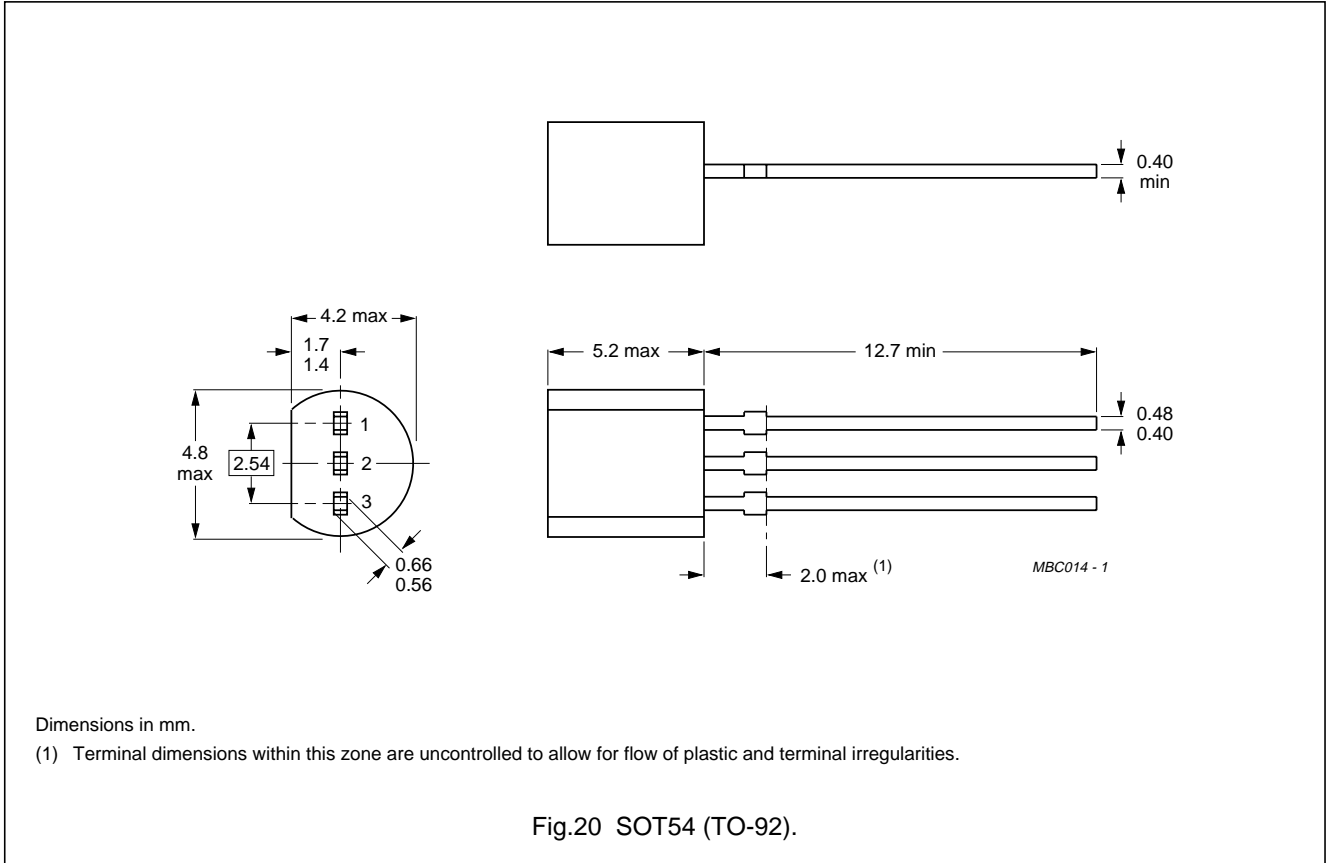

Fig.20 SOT54 (TO-92).

N-channel junction FETs

BF851A; BF851B; BF851C

DEFINITIONS

Data Sheet Status	
Objective specification	This data sheet contains target or goal specifications for product development.
Preliminary specification	This data sheet contains preliminary data; supplementary data may be published later.
Product specification	This data sheet contains final product specifications.
Limiting values	
Limiting values given are in accordance with the Absolute Maximum Rating System (IEC 134). Stress above one or more of the limiting values may cause permanent damage to the device. These are stress ratings only and operation of the device at these or at any other conditions above those given in the Characteristics sections of the specification is not implied. Exposure to limiting values for extended periods may affect device reliability.	
Application information	
Where application information is given, it is advisory and does not form part of the specification.	

LIFE SUPPORT APPLICATIONS

These products are not designed for use in life support appliances, devices, or systems where malfunction of these products can reasonably be expected to result in personal injury. Philips customers using or selling these products for use in such applications do so at their own risk and agree to fully indemnify Philips for any damages resulting from such improper use or sale.